

FDUM36KXE6F

Specifications

Nominal cooling capacity		kW	3.6
Nominal heating capacity		kW	4.0
Power source			1 Phase 220-240V, 50Hz
Power consumption	Cooling	kW	0.10-0.10
	Heating	kW	0.10-0.10
Sound power level		dB(A)	60
Sound pressure level Cooling		db(A)	P-Hi:37 Hi:32 Me:29 Lo:26
Exterior dimensions unit	H x W x D	mm	280 x 750 x 635
Net weight		kg	29
Air flow		m ³ /min	P-Hi:13 Hi:10 Me:9 Lo:8
Maximum external static pressure		Pa	100
Outside air intake			Possible
Air filter, Q'ty			Filter kit:UM-FL1EF/UM-FL2EF/UM-FL3EF(option)
Remote control(option)			wired:RC-EX3A, RC-E5, RCH-E3 wireless:RCN-KIT4-E2
Installation data Refrigerant piping size		mm(in)	Liquid line:ø6.35(1/4") Gas line:ø12.7(1/2")

The data are measured under the following conditions(ISO-T1).

Cooling: Indoor temp. of 27°CDB, 19°CWB, and outdoor temp. of 35°CDB.

Heating: Indoor temp. of 20°CDB, and outdoor temp. of 7°CDB, 6°CWB.

External static pressure of indoor unit is 10Pa.

The sound level indicates the value of rear-intake type with duct in anechoic chamber. During operation these values are somewhat higher due to ambient conditions.

Schematics

1KXE6F, 36KXE6F, 45KXE6F, 56KXE6F

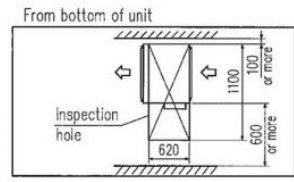
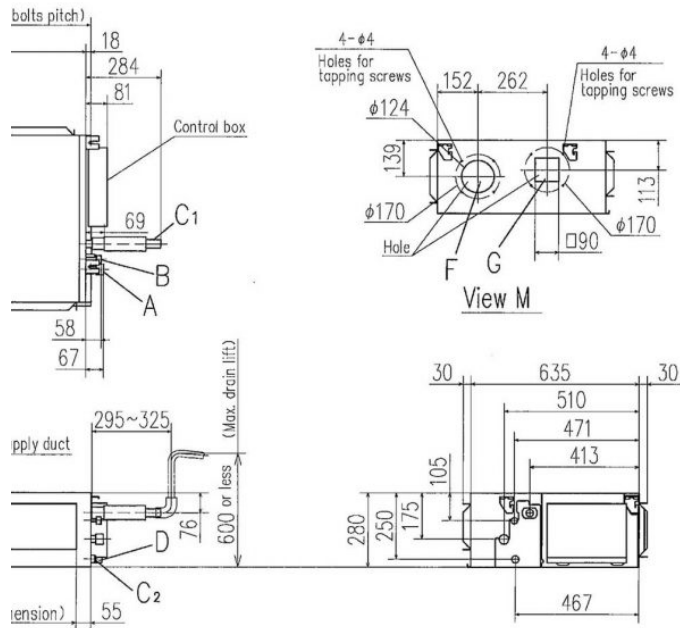

Symbol	Model
A	Gas piping
B	Liquid piping
C1	Drain piping
C2	Drain piping (Gravity discharge)
D	Hole for wire suspension
E	Suspension
F	Outside air for ducting
G	Air outlet for ducting
H	Inspection

Note: The model number

